

EcoPower B8X 55 – 300 t

Precision, Energy efficiency, Dynamic

world of innovation



ENERGY EFFICIENT – DYNAMIC – PRODUCTIVE

The optimum in performance and precision

The advantages

- » Dynamic toggle clamping unit with highly sensitive mold protection
- » High-precision injection units with extreme shot-by-shot accuracy
- » Force savings of 15% due to dynamic toggle kinematics
- » Fast, precise and efficient thanks to servo drive axes with parallel operation
- » Additional energy bonus through patented KERS energy recovery system
- » Newly developed WITTMANN amplifier – optimally harmonized to the drives
- » User-friendly through the Unilog B8X control system with integrated assistance systems
- » “Plug & Produce” extension into a full-fledged production cell possible with WITTMANN auxiliary equipment and the Wittmann 4.0 integration package
- » Optimal price/performance ratio



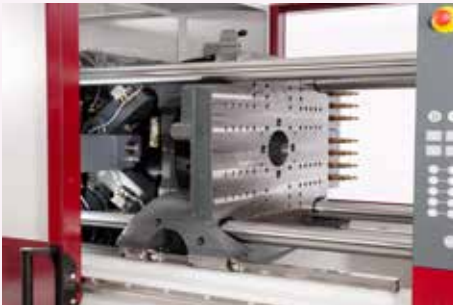

EcoPower B8X

The system-highlights

- » **Direct servo drives for main movements**
The EcoPower B8X machines come with highly dynamic servo motors to drive the main movements (closing/opening, plasticizing, injection). The mold height adjustment device in the clamping unit is also driven by a servo-electric motor. The ancillary strokes (ejector, nozzle stroke/contact pressure, core pulls) are driven by an integrated servo-hydraulic aggregate powered by a servo-electric motor. Direct servo-mechanic drives are available as an option.
- » **Powerful injection unit**
The EcoPower B8X injection units are equipped with a twin drive system for the injection and dosing functions. A torsion-resistant, one-piece cast iron frame with linear guides and a central ball screw drive provides the basis for highly dynamic, precise movements. The injection unit is pivotable and designed for easy access.
- » **Fast toggle clamping system**
The EcoPower B8X clamping unit is a 3-platen/4-tie-bar system with a dynamic 5-point toggle lever, driven directly by a servo motor via a rack-and-pinion drive. The moving platen of the machine travels on linear guides and rotating roller bearings without coming into contact with the tie-bars. Injection can already start during clamping force build-up.
- » **KERS – energy recovery is standard**
The KERS (Kinetic Energy Recovery System), patented for injection molding machines, converts the kinetic energy released by braking processes into electrical energy. The resulting current is used within the machine, e. g. for barrel heating. With KERS, the energy consumption can be cut further by up to 5%.
- » **Mould Protect – fast-response mold protection**
The minimal rolling friction of the clamping plate guides combined with high scan rate measurement of the amplifier signals from force changes directly on the toggle lever drive, and of the tie-bar expansion (basic protection), provides optimal conditions for fast mold protection from the very first cycle.

CLAMPING UNIT

Servo-electric dynamics and speed

- » **Ample space for complex molds**
 - Generously dimensioned mold platens [1] and a clean toggle lever clamping system offer the optimal environment for all molds including all media connections.
 - The ejector area and the environment of the platens offer easy access for machine setup and adjustment work. [2]
- » **Sensitive and precise**

In the EcoPower B8X clamping system, the tie-bars are exclusively used for force transmission between the outer platens. The moving platen travels virtually free of friction across the linear bearings without coming into contact with the tie-bars. [3]
- » **Servo-electric dynamics**
 - The moving platen is moved quickly and with high precision by a self-locking 5-point toggle lever. [4]
 - Short dry cycle time
 - Long service life
 - Low maintenance
 - The toggle lever is driven by a highly dynamic servo motor via a rack-and-pinion drive system. [5]
 - The synchronized mold height adjustment via 4 bronze bar nuts and a sun gear system is driven by a servo motor. In this way, an extremely accurate clamping force regulation can be achieved. [6]
- » **Servo-hydraulic ancillary strokes**

To drive the ancillary strokes (ejector, nozzle strokes and core pulls), a hydraulic aggregate powered by a servo-electric motor is mounted on the inside of the machine frame. Being specially designed for high efficiency, it requires no cooling water connection. The maintenance-friendly access is from the rear, behind the clamping unit. Servo-mechanical drives for the ancillary strokes are available as options.

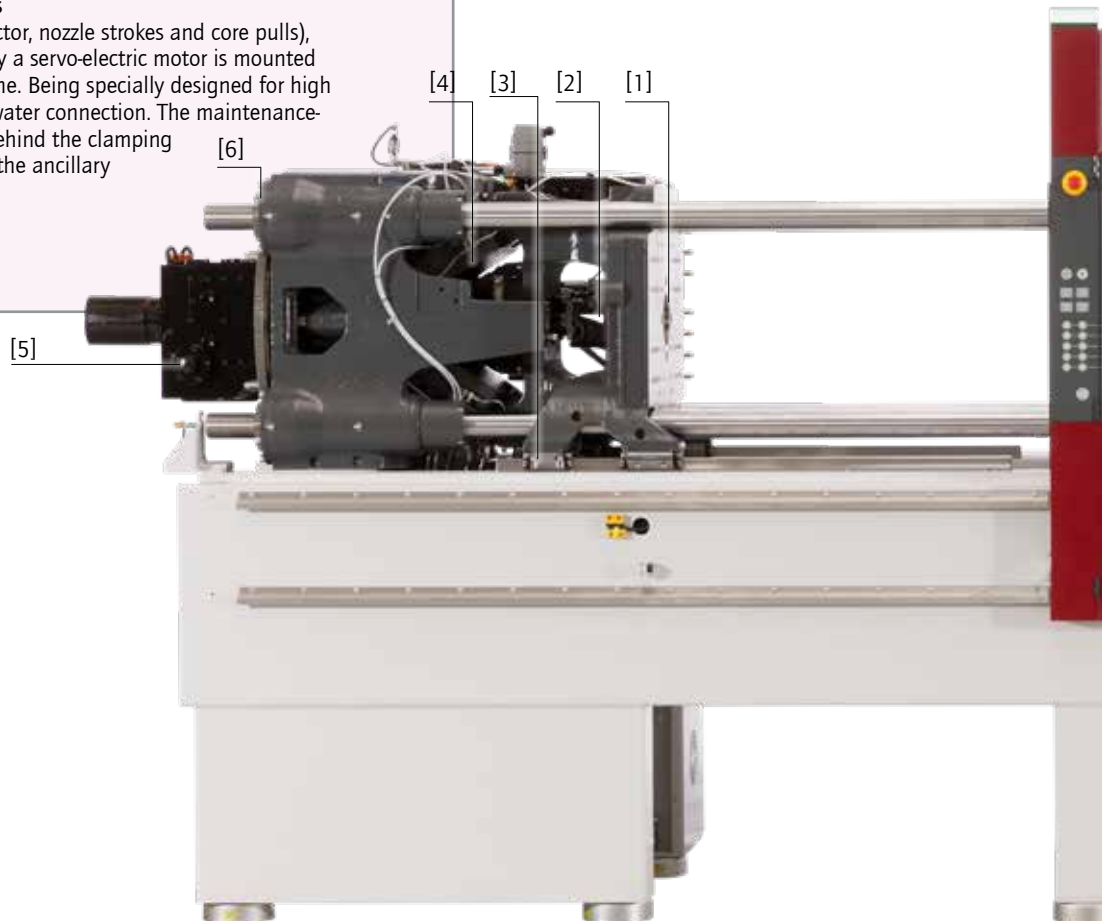

INJECTION UNIT

Repeatability

Wittmann

- » **Everything to ensure series consistency**
 - All screws ≥ 25 mm come with a 22:1 L/D ratio.
 - All injection units offer a wide injection pressure range.
 - Plasticizing parallel to clamping unit movements and start of the injection process during clamping force build-up are possible as standard.
 - Moment-free nozzle contact thanks to axial configuration of traveling cylinders [7]
 - Plasticizing units can be mounted to different injection aggregates with identical screw diameters.
 - In combination with WITTMANN BATTENFELD HiQ software packages sensitive adjustment facilities are available in the form of (optional) software modules to compensate environmental factors such as temperature and moisture, regrind or masterbatch content.
- » **Optimal operational excellence**
 - Quick barrel exchange due to swiveling injection unit.
 - Easy access for changeover work thanks to compact design and sliding guard [8]
- » **More productivity and efficiency**
 - High-resolution absolute value encoder for precise control [9]
 - Low-noise injection spindle with modern ball screw drive and "spacer" technology [10]
 - Oil bath lubrication for easier maintenance and improved dynamics



Anti-wear options

In addition to the premium-quality standard equipment, an extensive range of options is available to provide extra anti-wear and/or anti-corrosion protection. Predefined option packages and a selection matrix facilitate the selection of the right plasticizing unit.

DRIVE TECHNOLOGY

Energy efficiency and precision

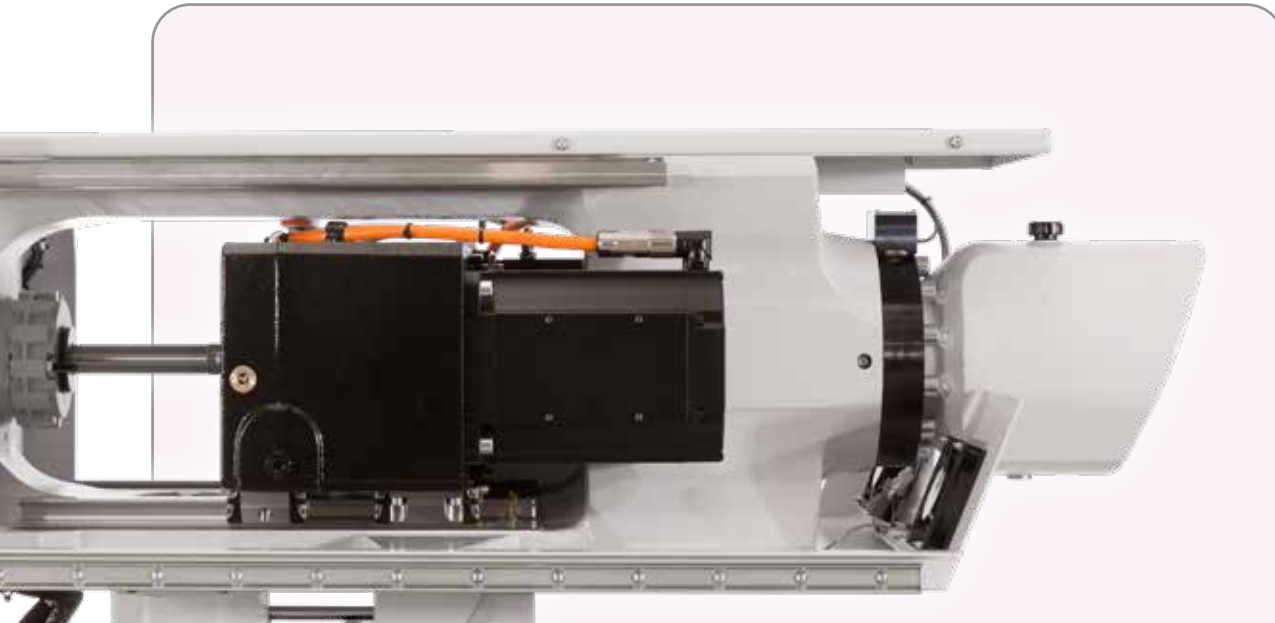

Fast-responding, precise, cost-efficient

The use of servo-electric drive technology for all main movements affecting the cycle offers a large number of advantages compared to conventional hydraulic injection molding machines:

- » Energy efficiency through direct drive via gearbox
- » Energy efficiency through the servo drives' high efficiency rates
- » Digital control for maximum repeatability
- » Use of recovered braking energy via KERS system for powering of heater bands
- » Cycle flexibility thanks to possibilities with parallel movements
- » Low sound emission (< 65 dBA)

The combination of servo motors and drive units (rack-and-pinion drive for the toggle lever and spindle drive for the injection stroke) can be supplied at different performance levels for different speeds.

Basically, the EcoPower drive concept offers the advantage of modularity for demand-oriented adjustment of drive performance to the intended use in each case. The new WITTMANN amplifier developed for the EcoPower B8X, with its high sampling rate, significantly improves reproducibility and injection dynamics.

„Drive-on-Demand 2.0“ servo-hydraulic drive for ancillary strokes

„Drive-on-Demand 2.0“ is the innovative combination of a fast-responding, speed-controlled and air-cooled servo motor with a high-quality constant displacement pump.

- » Integrated in the machine frame without additional space requirements
- » Drive unit for hydraulic core pulls
- » Energy-efficient, maintenance-free nozzle contact with high pressure
- » No cooling required for standard applications



INSIDER CONCEPT

"ex works" production cell

Wittmann

The insider concept is an ex-works solution to transform an EcoPower B8X injection molding machine into a fully fledged production cell. In its basic version, the equipment cell integrates a parts handling system, a conveyor belt for parts transport and a protective housing firmly connected with the machine. Additional equipment modules for further processing, quality documentation and packaging are available as options. For the design and configuration of such higher automation levels, WITTMANN BATTENFELD places the combined expert knowledge of the entire group at its customers' disposal.

The advantages of insider automation

- » **Material flow systematization**
thanks to a uniform logistics interface for finished parts transfer at the end of the clamping unit, a prerequisite for positioning of several machines in rows
- » **Reduction of production space**
by up to 50 % compared to conventional automation solutions
- » **Minimization of robot cycle times**
through shorter travel paths and immediate parts depositing on conveyor belt
- » **Easy access in spite of integration**
to the mold and the robot thanks to mobility of the conveyor belt integrated in the protective housing
- » **Cost benefits,**
since safety features for all danger areas are already in place and certified ex works.
- » **CE mark included**
for every machine with an insider solution. No more costs for individual approval.



CE certified by type examination



DC TECHNOLOGY

Direct Current as energy source

The WITTMANN Group is the first manufacturer of turnkey systems to offer machines and production cells able to make direct use of energy from renewable sources such as photovoltaics. Using a local DC Microgrid such as supplied by innovergy AG, the injection molding machine, as well as robots and temperature controllers, are powered directly by solar energy via a DC intermediate circuit. In addition, storage batteries can be used, so that any excess energy, for example solar power, can be stored efficiently for effective use later on.



Direct use for more efficiency

- » **No conversion loss:** Direct use of the DC current generated by the photovoltaic system via a DC microgrid reduces the transformation losses caused in conventional power supply with alternating current by the constant changeover from AC to DC and vice versa. The result is a significantly more efficient energy transfer.
- » **Optimal use of the deceleration energy** released by the machine and the WITTMANN robots thanks to KERS (Kinetic Energy Recovery System). The energy recovered from movements can be used not only within the production cell, but also by all consumers integrated in the DC microgrid. A further move to increase efficiency.
- » **Elimination of reactive current transmission:** Reactive power losses can be minimized and energy transmission can be improved by using direct current.

OPTIMIZED PRODUCTION CELL



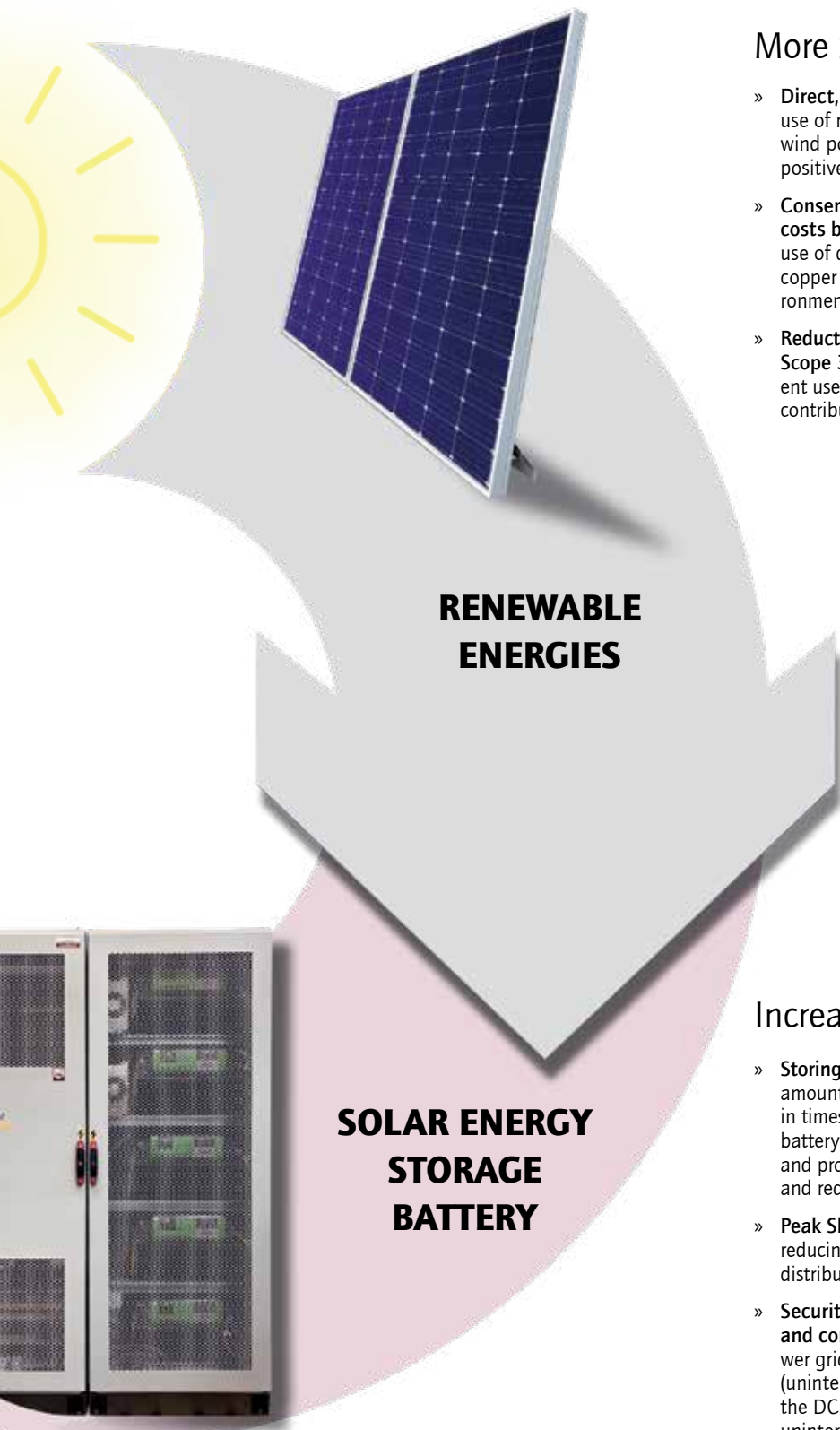

More Sustainability

- » **Direct, efficient use of renewable energy sources:** Direct use of renewable energy sources, such as solar energy or wind power, not only cuts energy costs, but also makes a positive contribution to protecting the environment.
- » **Conservation of resources and reduction of investment costs by up to 50% savings of copper** in a DC grid. The use of direct current enables more efficient utilization of copper cables, thus saving copper and reducing the environmental impact.
- » **Reduction of CO₂ emissions (Greenhouse Gas Protocol Scope 3):** By conversion to renewable energies and efficient use of energy, the CO₂ footprint can be reduced, which contributes to climate protection.

Increasing stability and reducing costs

- » **Storing energy:** Photovoltaic systems produce fluctuating amounts of electric energy. To continue using solar power in times of no sunshine, it makes sense to use a storage battery unit. This increases the internal consumption rate and promotes independence from external power suppliers, and reduces the electricity costs.
- » **Peak Shaving:** Energy storage batteries can contribute to reducing costly load peaks. This leads to more even energy distribution and prevents network overloads.
- » **Security of supply through bridging of power failures and controlled production stop** in cases of prolonged power grid failure through integrated power storage batteries (uninterruptible power supply – UPS is already included in the DC grid). The integration of storage batteries offers uninterruptible power supply and protects the production process against unexpected power failures.

UNILOG B8X

Complex matters simplified

The proven Unilog B8 control system logic with the high-performance B8X hardware is the WITTMANN BATTENFELD solution to make the operation of complex processes easy. To this end, the integrated industrial PC has been equipped with an enlarged intuitive touch-screen control surface. The visualization is the interface to the Windows® 10 IoT operating system, which offers extensive capacity for process control. In addition to the swivel-mounted monitor screen unit, a fixed manual operating panel is installed in the central console.



Unilog B8X Highlights

- » **Operating logic**
with a high degree of self-explanation, similar to modern communication devices
- » **2 major operating principles**
 - Operating/movement functions via tactile keys
 - Process functions on touch screen (access via RFID, key card or key ring)
- » **Process visualization**
via 21.5" touch screen display (full HD), pivoting laterally
- » **New screen functions**
 - Uniform layout for all WITTMANN appliances
 - Recognition of gestures (wiping and zooming by finger movements)
 - Container function – split screen for sub-functions and programs
- » **Status visualization**
uniform signaling system across the entire WITTMANN Group
 - Headline on the screen with colored status bars and pop-up menus
 - AmbiLED-display on machine
- » **Operator assistance**
 - QuickSetup: process parameter setting assistant using an integrated material database and a simple query system to retrieve molded part data with machine settings pre-selection
 - Extensive help library integrated

The process in constant view

» SmartEdit

SmartEdit is a visual, icon-based cycle sequence programming facility, which enables direct addition of special functions (core pulls, air valves, etc.) based on a standard process via touch operation on the screen. In this way, a total user-defined sequence can be compiled from a sequence menu. This machine cycle, visualized either horizontally or vertically, can be adjusted simply and flexibly to the process requirements by finger touch with "drag & drop" movements.

The advantages

- Icon visualization ensures clarity.
- Clear events sequence through node diagram
- Alterations without consequences through "dry test runs"
- Theoretical process sequence can be quickly implemented in practice.
- Automatic calculation of the automation sequence based on the actual set-up data set without machine movements

» SmartScreen

- Partitioning of screen displays to visualize and operate two different functions simultaneously (e.g. machines and auxiliaries)
- Uniform design of the screen pages within the WITTMANN Group
- Max. 3 containers can be addressed simultaneously for the SmartScreen function.
- Adjustments of set values can be effected directly in the set value profile.

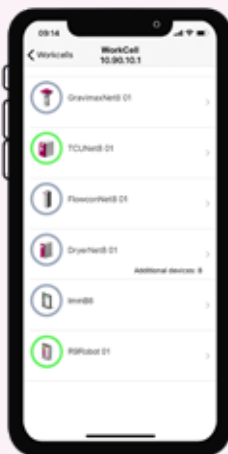
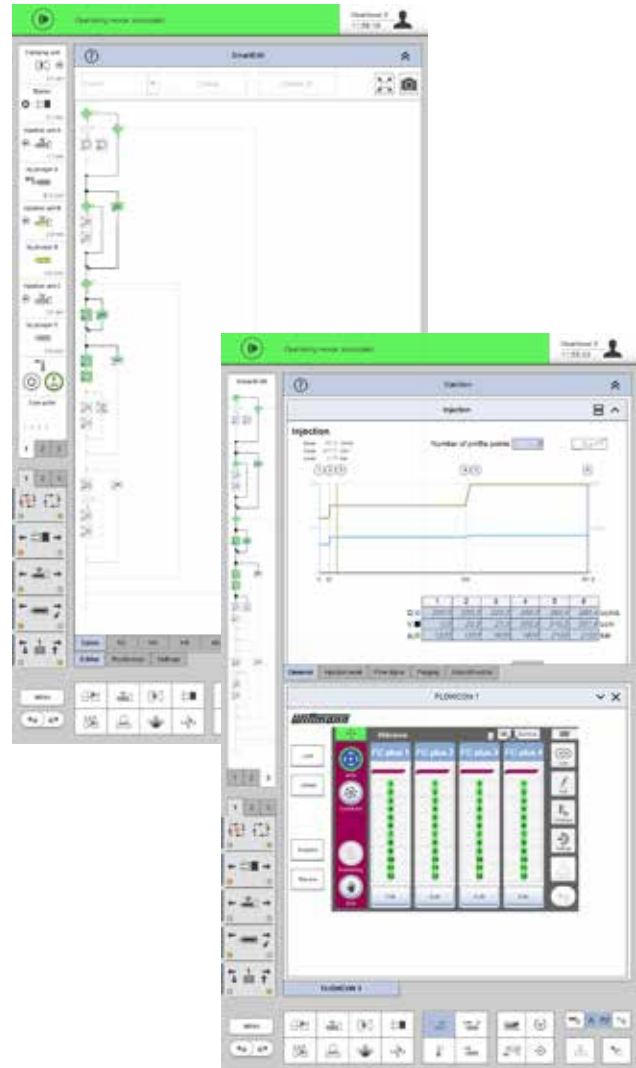

Remote communication

» QuickLook 4.0

Production status check via smartphone – simple and comfortable:

- Production data and statuses of all essential appliances in a production cell
- Complete overview of the most important production parameters
- Access to production data, error signals and user-defined data
- The production cell overview offers a clear, simple overview of the production cell's general condition and that of its individual Wittmann 4.0 appliances.

» Global online service network

- Web-Service 24/7: direct Internet connection to WITTMANN BATTENFELD service
- Web-Training: efficient staff training by means of the virtual training center

WITTMANN 4.0

Communication in and with production cells

With its communication standard Wittmann 4.0, the WITTMANN Group offers a uniform data transfer platform between injection molding machines and auxiliary equipment from WITTMANN. In case of an appliance change, the corresponding visualizations and settings are loaded automatically via an update function, following the principle of "Plug & Produce".

Connection of auxiliaries via Wittmann 4.0

- » **WITTMANN water flow regulator WFC 120, Gravimax blenders and Aton & Drymax dryers**
 - Units directly addressed and controlled via the machine's control system
 - Joint saving of data in the production cell, the machine and in the network via MES
- » **WITTMANN robots with R9 control system**
 - Operation of robots via the machine's monitor screen
 - High-speed communication between machine and robot to synchronize movements
 - Important machine movements can be set via the R9 robot control system
- » **WITTMANN Tempro plus D temperature controllers**
 - Setting and control of temperatures via the machine's control system possible
 - All functions can be operated either on the unit or via the machine's control system

Integration in MES system

The integration of machines and complete production cells in an MES system is a prerequisite for an efficient and transparent production facility according to the Industry 4.0 concept.

Depending on customers' requirements, small and medium-sized companies as well as global players are offered a compact MES solution based on TEMI+. With the Windows® 10 IoT operating system it is also possible to have selected status information from all connected machines on the production floor shown under SmartMonitoring on the display screen of every machine.

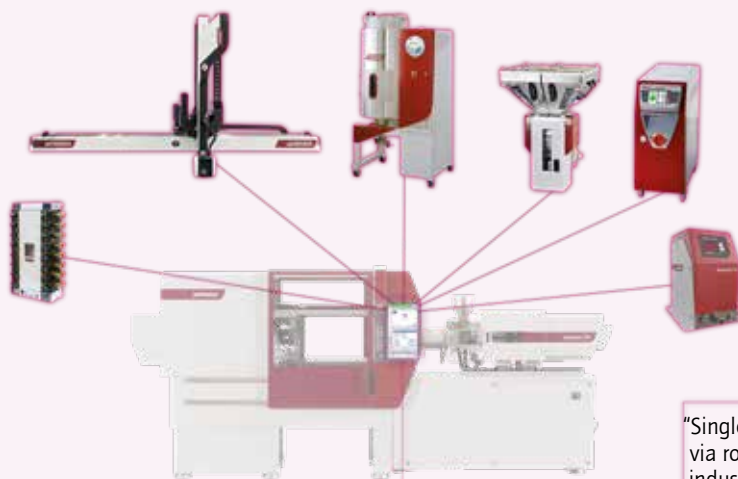

Wittmann 4.0 system

With Wittmann 4.0, a machine and its robots and auxiliaries are transformed into a uniform technical organism, which communicates externally via a specific IP address. Such a "Single Point Entry" with an integrated internal firewall substantially increases cyber security.

"Single Point Entry" via router into the industry 4.0 world

OPTIONS

Modular and flexible

Wittmann

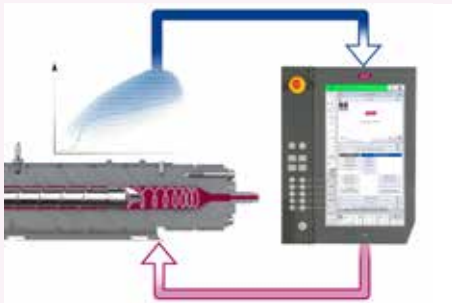

EcoPower B8X

The option highlights

- » **Faster ejection**
As an alternative to the standard servo-hydraulic drive for the ejector, a more powerful version with a servo-mechanical drive is available as an option.
- » **Cleanroom-fit mold space**
The mold platen drillings (EUROMAP) can be temporarily closed with plastic stoppers. The surroundings of the mold platens are lined with easy-to-clean stainless steel panels. If desired, the machine platens can be supplied with a reduced bore pattern.
- » **HiQ packages**
The HiQ packages offer add-ons for the existing Unilog B8X machine control system software. They provide additional features to give the operator more information about the process, and to facilitate operation of the equipment.
- » **Fast media connections**
For the ergonomically positioned standard connection points for cooling water, air and core pull hydraulics, optional fast-coupling plates (individual plates or system plates) can be supplied, as well as electrical plug-in systems for the hot runner heating circuits, temperature and pressure sensors and coding signals.
- » **WITTMANN auxiliaries**
The extensive range of the WITTMANN auxiliary equipment offers appropriate solutions for all secondary processes of injection molding, including parts handling, material feeding and drying, sprue recycling and mold cooling. Via the optional Wittmann 4.0 integration package, all additional auxiliaries can be integrated into the production cell according to the "Plug & Produce" principle.

APPLICATION TECHNOLOGY

Outstanding competence



Photo: Greiner BioOne GmbH

» Clean room injection molding

Whenever medical or electronic components need to be manufactured in a particle-free environment, the EcoPower B8X concept with its easy-to-clean mold space offers good basic conditions, which can be further optimized to meet more stringent requirements by adding optional equipment modules (such as water-cooled servo motors and clean room packages).



» Technical precision injection molding

The EcoPower B8X ensures highest standards of precision and reproducibility, with free-of-play force transmission and servo-electric drives. Technical parts such as SIM card holders can be produced with high accuracy and at high speeds. Minimal cycle times and reliable production processes ensure profitability and top-quality products.



» IML - In-Mold Labeling

The fast running EcoPower B8X machines in combination with the proven WITTMANN handling technology are the basic equipment for high-performance in-mold labeling production cells to make directly decorated containers.



» Combimould

Where two or more different plastic materials in different colors or with different attributes are to be combined into one part, the EcoPower B8X machines can be fitted with additional injection units in V or L configuration.



- » **LIM – Liquid Injection Molding**
LIM designates the injection molding process to make elastic parts from 2-component LSR (liquid silicon rubber). For LSR product manufacturing, WITTMANN BATTENFELD uses proven modular machine and automation concepts with special plasticizing systems adapted to the viscosity of LSR.



- » **PIM (CIM/MIM) – Powder Injection Molding**
Powder injection molding (PIM) is a manufacturing process for series production of parts made of metallic or ceramic materials. PIM is the ideal process to produce large quantities of complex, functional components with a high material requirements profile.



- » **Injection molding of high-precision components**
The high degree of precision in the movements of servo drives stands for an equally high level of precision and consistency of the injection parameters. This provides ideal conditions for processing engineering plastics into all kinds of high-precision components.

TECHNICAL DATA EcoPower B8X

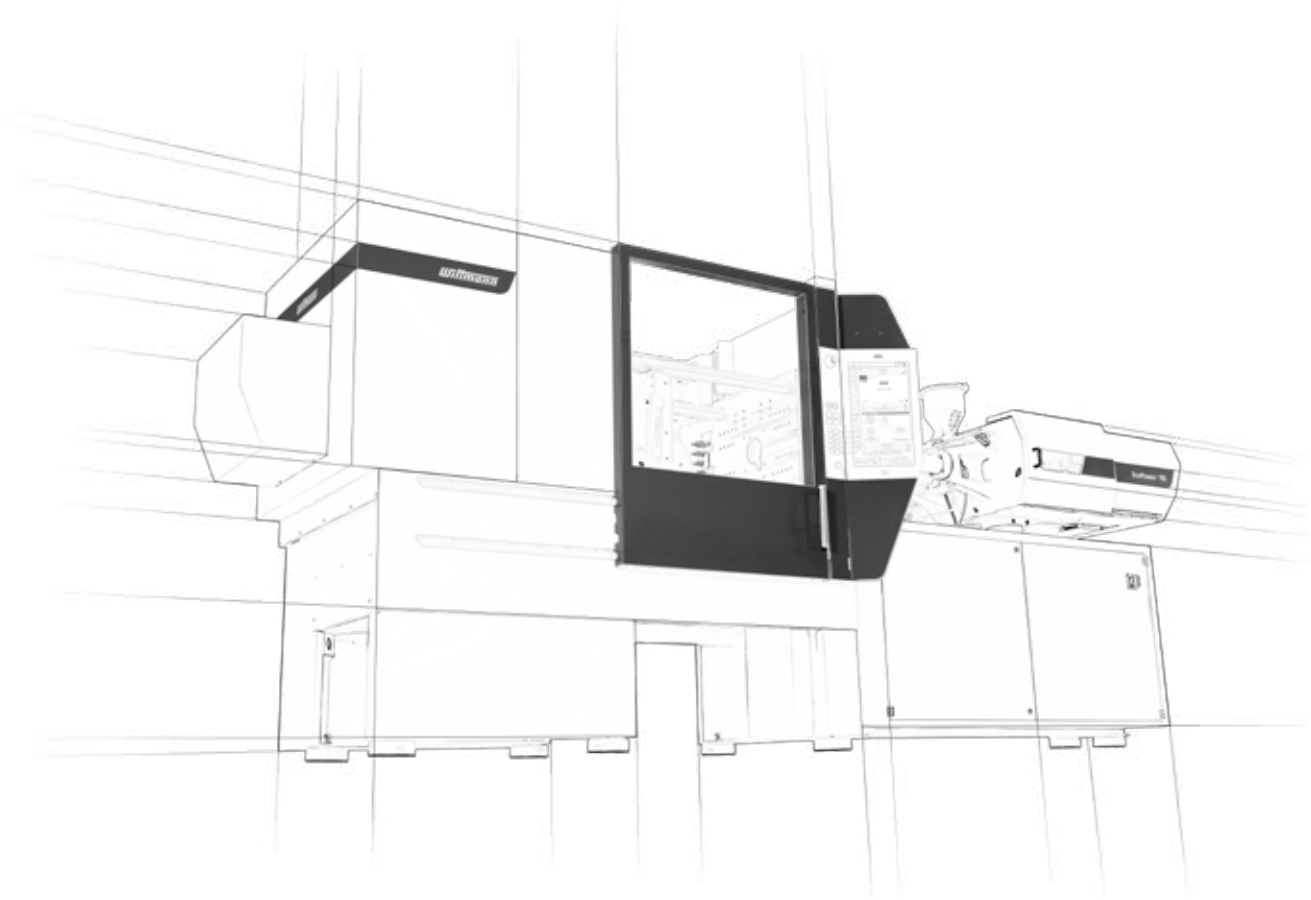

COMBINATIONS OF CLAMPING UNITS/INJECTION UNITS									
Clamping unit	Injection unit								
t	70	130	210	350	525	750	1000	1330	1670
55	•	•	•	•					
90		•	•	•	•				
110			•	•	•	•			
160				•	•	•	•		
180					•	•	•	•	
240						•	•	•	•
300						•	•	•	•

Material	Factor
ABS	0.88
CA	1.02
CAB	0.97
PA	0.91
PC	0.97
PE	0.71
PMMA	0.94
POM	1.15
PP	0.73

Material	Factor
PP + 20 % Talc	0.85
PP + 40 % Talc	0.98
PP + 20 % GF	0.85
PS	0.91
PVC hard	1.12
PVC soft	1.02
SAN	0.88
SB	0.88

The maximum shotweights (g) are calculated by multiplying the theoretical shot volume (cm³) by the above factor.

STANDARD

Base machine

Drop - voltage 230/400V/3p+N-TN/TT, 50 Hz
 Painting RAL 7047 tele grey / RAL 7016 anthracite/RAL 3004 crimson
 Air cooling system for drive and amplifier unit, water cooling system open for feeding zone and oil cooler with solenoid valve
 One-piece base frame with 3 disposal directions
 Ejection area - ejection shaft cover according to EN ISO 20430 incl. Interface for ejection flap control
 Printed operating manual incl. user manual on USB flash drive in any EU language acc. to definition of country

Operating manual in printed version incl. user manual on USB flash drive in any EU language according to definition of country incl. type examination certificate TÜV Austria in German incl. protocol: electrical safety according to EN 60204-1

Injection molding machine according to machinery directive 2006/42/EG incl. declaration of conformity and CE-marking

Levelling pads

Drive unit S0 with speed controlled servo motor for hydraulic pump to increase the energy efficiency, injection axis, dosing axis and clamping axis with energy-efficient and performance optimized direct servo drive

Clamping unit

Clamping force and closing and opening forces adjustable
 Mold safety program
 Moving platen supported by positioned linear guides
 Mold platen according to EUROMAP 2, clamping surface metallic bright, rest painted
 Fixing holes for robot on fixed platen as per EUROMAP 18
 Hydraulic multi stroke ejector
 Clamping system with 5-point twin toggle, servo electric direct drive via rack-and-pinion drive
 Servo electric mold height adjustment

Injection unit

Screw drive by A.C. servo-motor for parallel recovery during cycle
 Plasticizing unit AK+ for thermoset processing, 3-zone universal screw, flow-optimized check valve, heater bands up to 350 °C with heat insulation of feed zone grooving
 Thermocouple failure monitor
 Maximum temperature supervision
 Plug-in ceramic heater bands
 Temperature control of feed throat integrated
 Swivelling injection unit
 Linear guides in standard design, position sensor with non-contact stroke transducer
 Selectable barrel stand-by temperature
 Decompression before and/or after metering
 Physical units - bar, ccm, mm/s etc.
 Screw protection
 Auxiliary screw speed indication
 Linear interpolation of holding pressure set values
 Bar chart for barrel temperature with set value and actual value display
 Selectable injection pressure limitation
 Changeover from injection to holding pressure depending on stroke, time and pressure
 Open nozzle R35, split
 Splash guard and barrel covering in standard execution according to EN ISO 20430, L/D 22 protected via limit switch
 Material hopper 6 litres (MH206) for automatic material feed, sliding device with shut-off function for material with sliding guide

Safety gate

Covering injection side - maintenance door slidable with sensor
 Safety gate in standard execution, plexiglas clear / frame RAL 3004 crimson
 Safety gate at operator and non-operator side manually operated
 Monitored safety gate electrically controlled according to CE on front and rear side, safety gate free
 Maintenance-free safety gate locked by electromagnet
 Safety gate free for mold change and handling by robot

Electrics

Control zone for nozzle heater band 230 V
 AmbiLED status indicator
 Switch cabinet circulating fan for environment temperature to max. 30 °C
 Emergency stop switch button in control panel
 USB connection on control unit for printer or network
 1 Ethernet interface (switch cabinet)
 Integration package Wittmann 4.0 BASE: Router for integration respectively protection of injection moulding cell in production network

Control system

Control system Unilog B8X - 21,5" multi-touch screen (full HD)
 Control panel with selectable haptic keys
 Clamp force display and supervision
 Software for operating hours counter
 Closing/Opening - 5 profile steps
 Ejection forward/back - 3 profile steps
 Nozzle forward/back - 3 profile steps
 Injection/Holding pressure - 10 profile steps
 Screw speed/Back pressure - 6 profile steps
 Parts counter with good/bad part evaluation
 Purging program through open mold
 Stroke zero offset settings
 Start-up program
 Switch over to holding pressure MASTER/SLAVE by injection time, screw stroke/injection volume and injection pressure
 Self-teaching temperature controller
 Display of temperature inside electrical cabinet
 Seven-day timer
 Access authorization via RFID authorization system (1 x check card IT-level-15, 1 x token customer level-30 and 1 x token customer service level-20 are included in delivery)
 Freely configurable status bar
 Physical, process-related units
 Automatic dimming
 Logbook with filter function
 User programming system (APS)
 User page
 Note pad function
 Cycle time analysis
 Hardcopy function
 Internal data storage via USB connection or network
 Online language selection and selection of imperial or metric units
 Time monitoring
 Basic Quality Monitoring (1 freely config. network connection, quality table 1000 storage depth, events protocol (logbook) for 1000 events, actual value graphics with 5 curves, 1 envelope curves monitoring)
 Injection and Metering integral supervision
 Alarm message via e-mail
 SmartEdit - sequence editor
 QuickSetup - assistance program for initial parameter setting
 Energy consumption monitoring for motors and heating
 2 outputs, freely programmable

Base machine

Special voltage
Handling package with open machine safety gate on non operator side
Parts hopper, Parts chute for separation of good/bad parts or photoelectric ejection check
Non-standard mold height
Machine frame increased
Special paint

Hydraulics/Pneumatics

Hydraulics with oil cooler controlled in water inlet of cooling, oil level
Injection parallel to clamp force build-up
Raw filter in water inlet of cooling incl. adapter with ball valve for oil maintenance on oil tank
Hydraulic core pull for clamping plate, interface according to EUROMAP 13, incl. or without core pull pressure release
Pneum. core pull on clamping plate/nozzle plate, incl. pressure regulator
Hydraulic manifolds for one mold shut-off nozzle or more
Pneumatic manifolds for one mold shut-off nozzle or more
Air valves on nozzle plate/clamping plate
Compressed air pressure maintenance unit incl. 1 or more way pressure regulation incl. directional exhaust valve with blocking function

Clamping unit

Support for middle plate or heavy molds
Mold platen according to SPI, JIS, T-slots
Mold platen incl. cooling channels
Unscrewing device in lieu of ejector
Double check valve to keep ejector in end-position
Ejector cross according to EUROMAP/SPI/JIS
Mechanical or pneumatic ejector coupling
Ejector platen safety
Mechanical mold safety mechanism

Injection unit

Splash guard and barrel covering in standard execution according to EN ISO 20430, L/D 22 protected via transponder switch
Plasticizing unit AK++ in high wear and corrosion resistant execution
Plasticizing unit AKCN in wear and corrosion resistant execution, for processing PMMA, ABS and PC
Barrier section, screw with mixing section
Ball type screw tip
Melt pressure transducer, melt temperature sensor
Heater bands up to 450 °C
Plasticizing unit in special execution for LIM, MIM, CIM, Cellmould
Open nozzles in special execution
Needle type shut-off nozzle operated pneumatically
Pneumatic cross-bolt type shut-off nozzle
Open Airmould nozzle, pressure controlled
Barrel covering and splash guard in special execution
Vacuum package incl. vacuum pump
Material hopper in special execution
Hopper magnet

Safety gate

Safety gate clamping side, rear side and/or operator side elevated, lowered or extended
Insider package WITTMANN rear side incl. conveyor belt
Front side gate safety system for manual part removal incl. clearance of ejector

Cooling and conditioning

Cooling water distributor with/without blow-off valve
Solenoid valve for cooling water distributor
Machine cooling by T-piece in inlet pipe
Filter back flushable/water pressure supervision in inlet pipe
Distributor block on nozzle plate/clamping plate
WFC 120 integrated into control system

Electrics

Emergency stop switch button in control panel and on non operator side
Temperature control zones for hot runner
Acoustic element integrated in signal lamp
Socket combination
Additional fan in electric switch cabinet for increased environment temperature
Cabinet air conditioner
Interface for robot, conveyor belt, TCU, dosing unit, Airmould, production data logging system, RJG eDart, Priamus BlueLine, danger zone boundary, ejection in mold middle plate, brushing device, relay signals, vacuum pump

Control system

Cavity pressure switch over
BNC sockets for injection process analysis
Expert Quality Monitoring (4 freely configurable network connections, quality table with 10000 storage depth, events protocol (logbook) for 10000 events, actual value graphic with 16 curves, 4 envelope curves monitoring, SPC charts, trend diagrams)
Mold identification
Special programs on customer request
HiQ Packages
Software Tandemmould, multiple data sets
Energy consumption analysis
Injection compression and venting program
Initiation of next cycle by closing safety gate
Special program ejection of cold slug
Additional output card/input card, freely programmable
Integration package Wittmann 4.0

Additional equipment

Plinth for robot
Tool kit
Lighting in mold space
Mold clamping systems in mechanical or electrical execution
Integration package (robot, feeder, dosing unit, TCU, mold integration)
WITTMANN BATTENFELD web service during warranty period free of charge
Remote control package

The Wittmann logo is located in the bottom right corner of the page. It consists of the word "Wittmann" in a white, italicized, sans-serif font, set against a dark red, rounded rectangular background.

WITTMANN BATTENFELD GmbH

Wiener Neustädter Strasse 81

2542 Kottlingbrunn | Austria

Tel.: +43 2252 404-0

info@wittmann-group.com

www.wittmann-group.com